

# ACRYLIC GLASS EFFECT SIGNS

Available in clear green and clear

## GLASS EFFECT SIGNS

These signs are touch-safe, shatter proof and weather resistant.  
All of the stock shapes shown here are available for next day despatch.

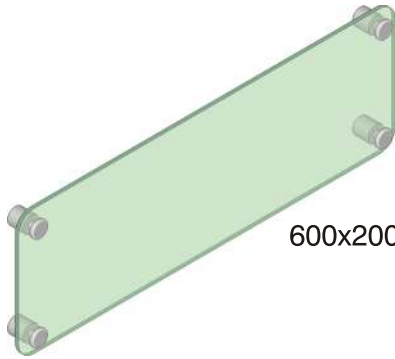

600x200mm

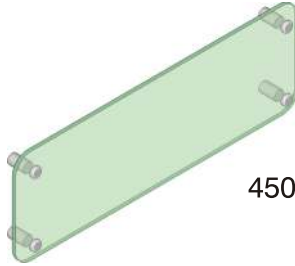

450x150mm

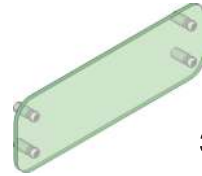

300x100mm

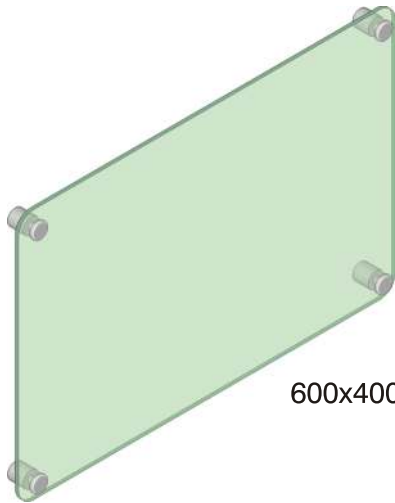

600x400mm

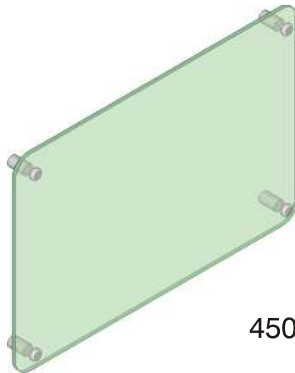

450x300mm



300x200mm

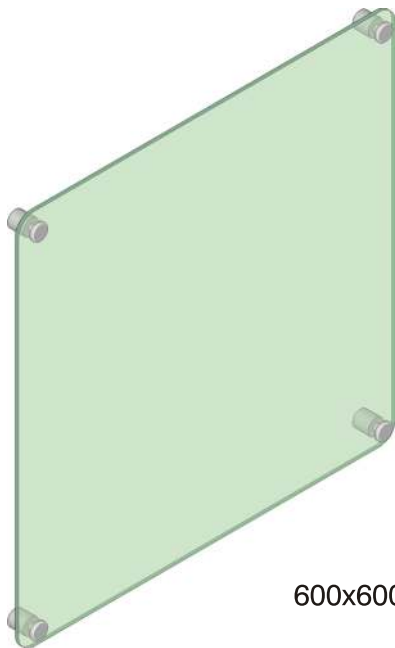

600x600mm

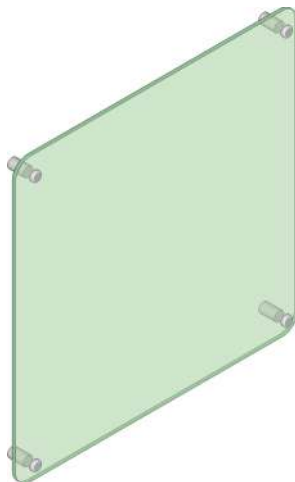

450x450mm



300x300mm



# Glass Acrylic Signs

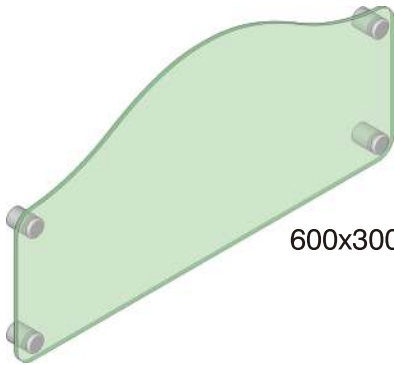

600x300mm

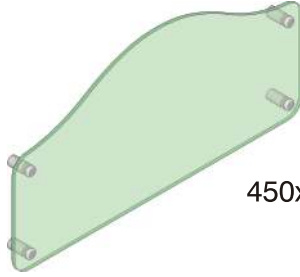

450x225mm

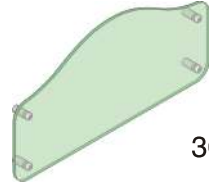

300x150mm

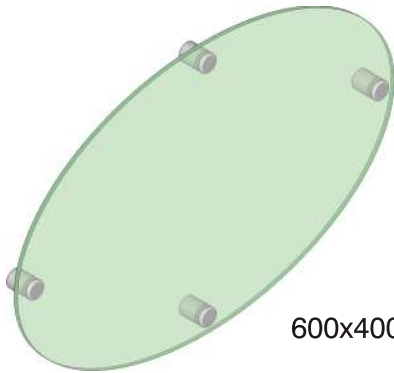

600x400mm

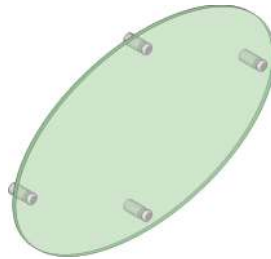

450x300mm



300x150mm

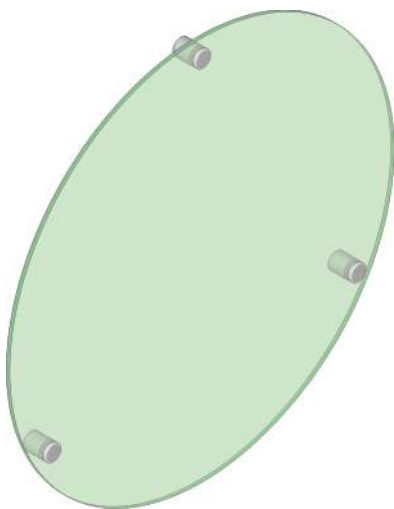

600mm

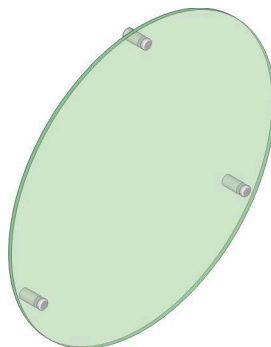

450mm

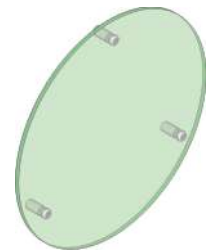

300mm

All signs are supplied with the addition of a free universal paper template.

## GLASS EFFECT DIRECTORIES

10mm thick glass effect signs, laser cut for perfect alignment. Supplied at stock sizes with stand-offs, next day to your door.

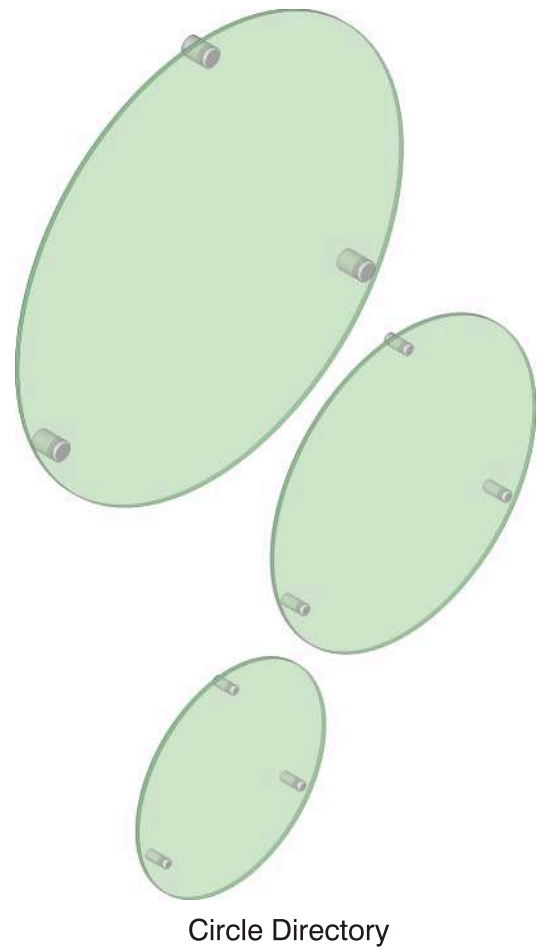
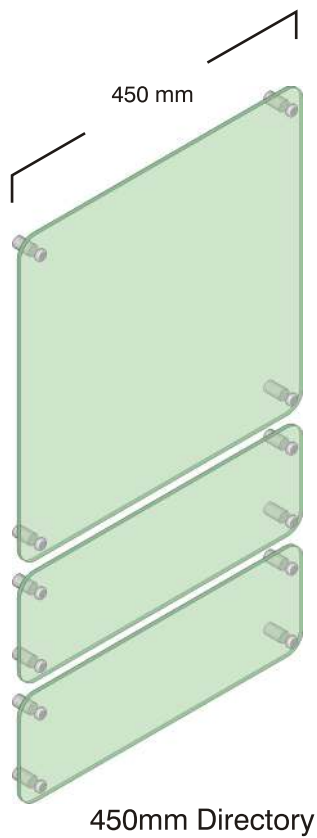
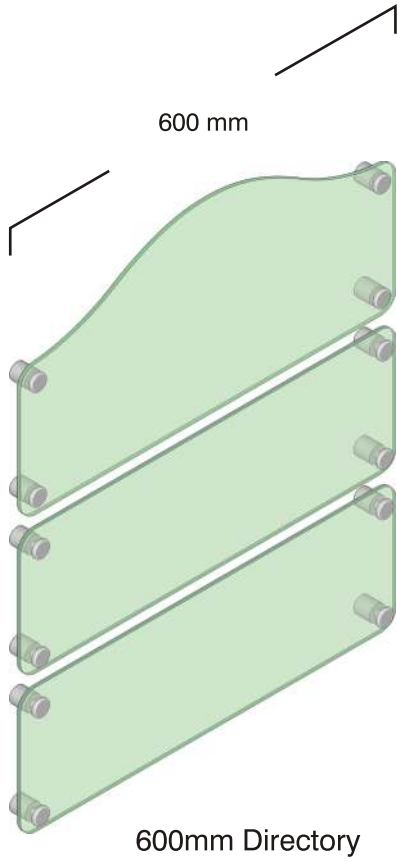

All signs are supplied with the addition of a free universal paper template.

## BESPOKE GLASS SIGNS

3, 5 & 10mm thick glass effect signs cut to your specification, within 5-7 working days.

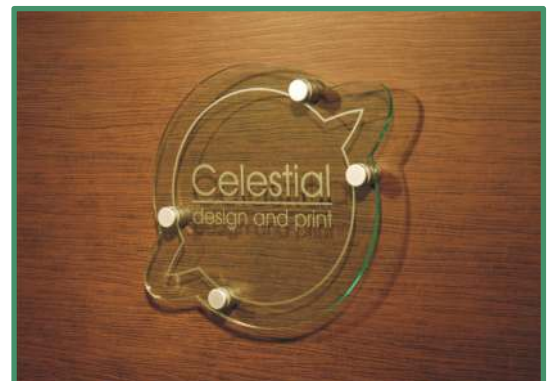
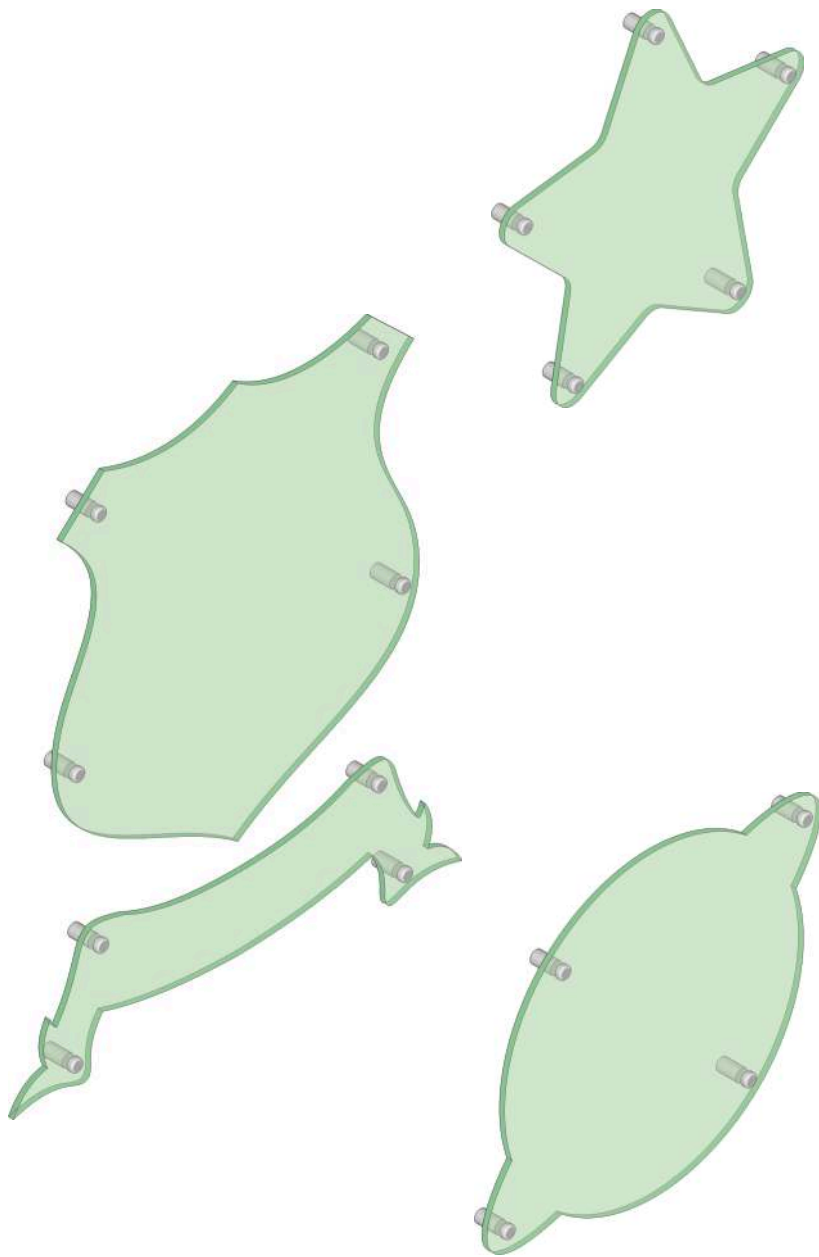

## UNIVERSAL PAPER TEMPLATE

All signs are supplied with the addition of a free universal paper template.

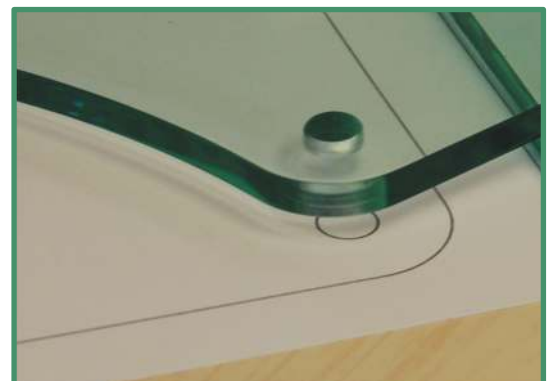

## OPTIONAL BACKING PANEL

Order any of the glass effect signs with an optional backing panel that will enhance vinyl graphics from behind. Supplied in a standard range of colours, the backing panel also acts as a template for easy fitting.

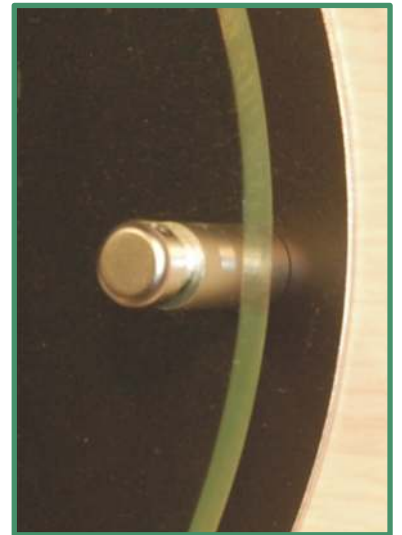

## STAND-OFF CONNECTORS

Stand-off connectors are available in two different finishes - silver satin and chrome.

Like all Ashby products they are easily assembled in minutes giving a neat and tidy finish with a minimum of effort.



12 x 25mm



15 x 30mm



25 x 36mm